



# INSTALLATION INSTRUCTIONS

Accessory  
**AIR CONDITIONER**  
2-DOOR DX  
4-DOOR DX

Application  
**2006 CIVIC**  
2- AND 4-DOOR

Publications No.  
**All 31246-31447**

Issue Date  
**NOV 2005**

## TOOLS AND SUPPLIES REQUIRED

Phillips screwdrivers [1 stubby and 1 extra long  
(150mm or 6" shaft)]  
Small flat screwdriver  
Feeler gauge set  
Ratchet with extensions (wobble or universal extension  
and 8 mm, 10 mm and 12 mm sockets  
Combination wrench (10 mm, 19 mm, 22 mm, 24 mm,  
and 27 mm)  
Belt tension release tool #YA9317  
Diagonal cutters  
Utility knife  
Clip remover tool  
Torque wrench  
M5 bolts  
M6 bolts/nut  
M8 bolts

## INSTALLATION INSTRUCTIONS

**Customer Information:** The information in this installation instruction is intended for use only by skilled technicians who have the proper tools, equipment, and training to correctly and safely add equipment to your vehicle. These procedures should not be attempted by "do-it-yourselfers."

NOTE: Be careful not to damage the body paint finish.

1. Write down the radio station presets.
2. With the ignition switch on, turn on the windshield wipers. When the wipers reach the top position turn off the ignition switch.
3. Disconnect the negative cable from the battery.

4. Inside the passenger's compartment, remove the passenger dashboard undercover and then the glove box (two 8 mm washer-bolts for the hinges, then open the glove box to remove).

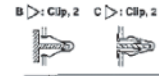

UNDERCOVER

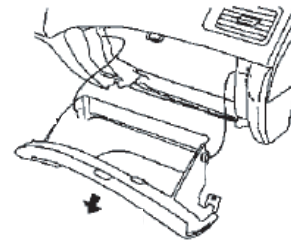
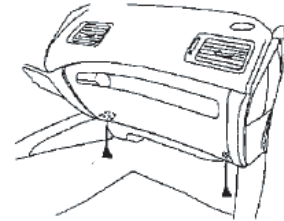
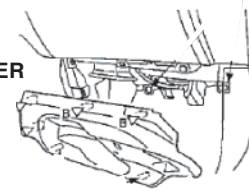

SVA 2-DOOR AIRCON SYSTEM  
UNDERHOOD BOLT ORIENTATION

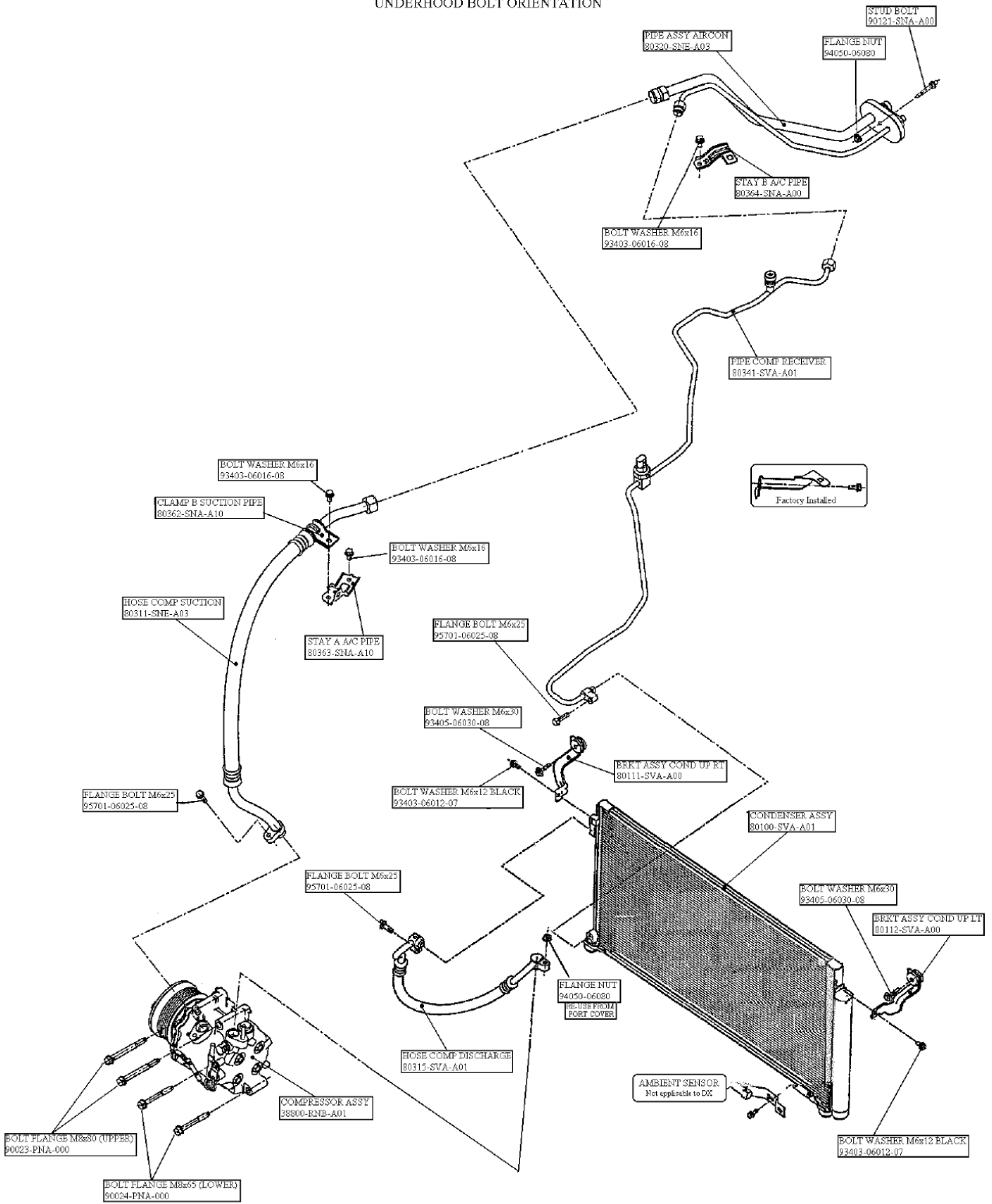

SVA 2-DOOR AIRCON SYSTEM  
UNDERHOOD BOLT ORIENTATION

**PRELIMINARY**

SNA 4-DOOR AIRCON SYSTEM  
UNDERHOOD BOLT ORIENTATION

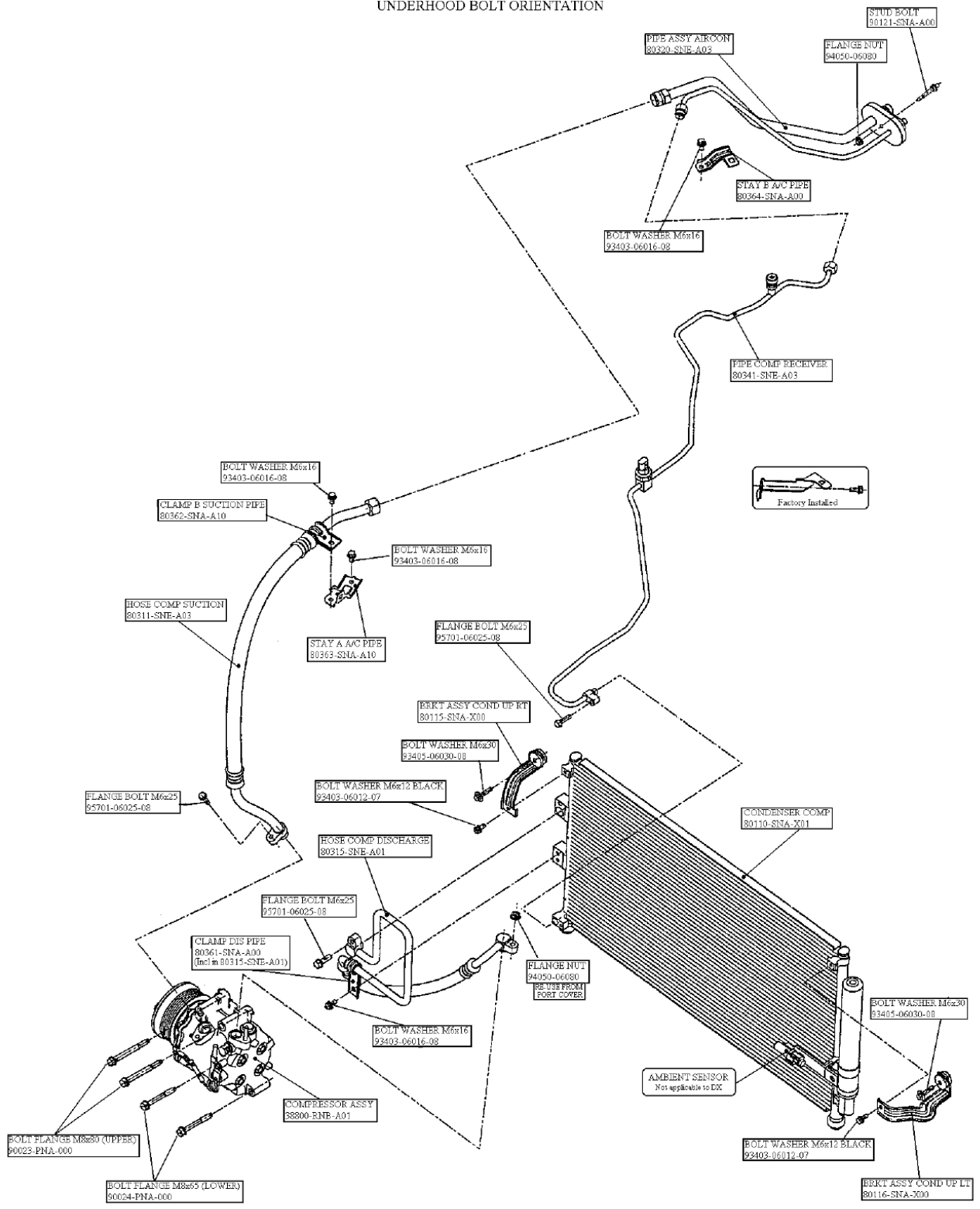

SNA 4-DOOR AIRCON SYSTEM  
UNDERHOOD BOLT ORIENTATION

**PRELIMINARY**

**Group A**

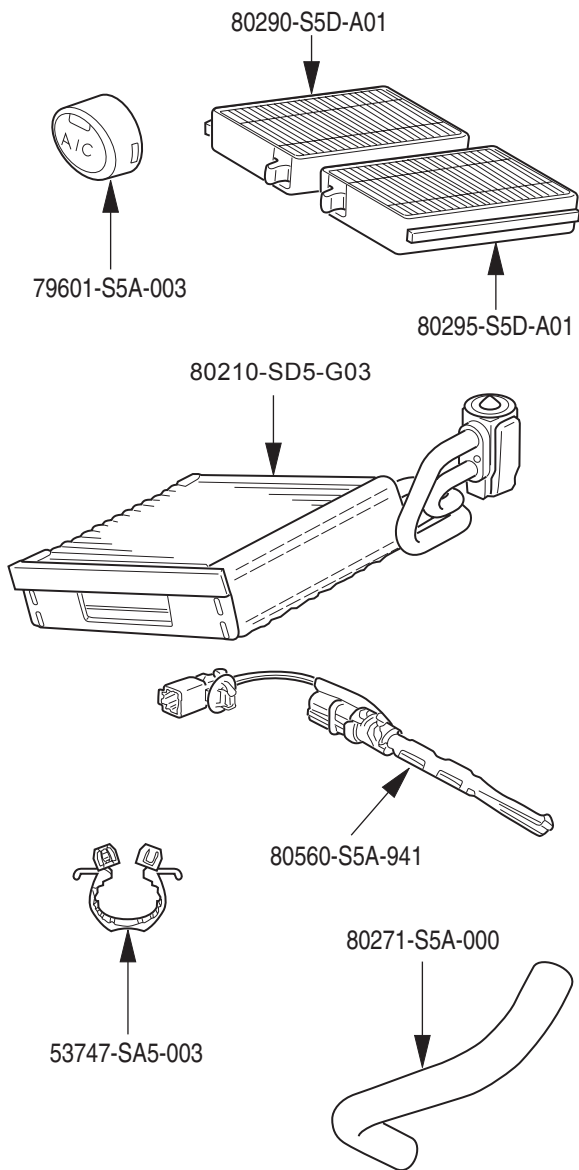

Group	Part	P/N	Qty
<b>A</b>	Drain hose clip	53747-SA5-003	1
	A/C button	79601-S5A-003	1
	Evaporator	80210-S5D-G03	1
	Drain hose	80271-S5A-000	1
	Dust and pollen filter A	80290-S5D-A01	1
	Dust and pollen filter B	80295-S5D-A01	1
	Evaporator sensor	80560-S5A-941	1
<b>B</b>	Wire ties	38221-SW5-300	2
	Condenser fan assembly	38605-PMM-A12	1
	Compressor	38800-PLM-A12	1
	Compressor belt	38920-PLR-004	1
	Heat insulator	38935-PLM-A00	1
	Condenser assembly	80100-S5A-T01	1
	Right condenser bracket	80107-S5A-000	1
	Left condenser bracket	80108-S5A-000	1
	Suction line	80311-S5D-A12	1
	Discharge hose	80315-S5A-013	1
	A/C suction line and receiver line B	80320-S5D-A12	1
	Condenser line	80331-S5D-A11	1
	Receiver line	80341-S5D-A02	1
	Receiver	80350-S5D-A01	1
	Suction hose clamp A	80360-S5A-A00	1
	Suction hose bracket	80361-S5A-A00	1
	Suction line bracket	80363-S5A-A01	1
	Receiver line clip A	80381-S5A-A01	1
	Receiver line clip B	91548-S5A-003	1
	A/C wire harness	80460-S5A-A00	1
	Flange bolts, 8 x 100 mm	90023-P2A-000	4
Ground bolt, 6 x 12 mm (brass-colored)	90153-SE0-003	1	
Paint cutting nut, 6 mm (yellow-tinted)	90361-SV4-003	3	
Washer-bolt, 6 x 12 mm (yellow-tinted)	93403-06012-08	1	
Washer-bolts, 6 x 16 mm (gray-colored)	93403-06016-05	7	
Flange bolts, 6 x 12 mm (yellow-tinted)	95701-06012-08	2	
Flange bolts, 6 x 25 mm (yellow-tinted)	95701-06025-08	4	
Flange bolt, 6 x 30 mm (yellow-tinted)	95701-06030-08	1	
<b>C</b>	Power relay (4P)	39794-S0K-A01	2
	Information label (Canada)	80050-SP0-000	1
	Information label (USA)	80050-SR3-H00	1
	A/C kit identification label (USA)	8005X-S5D-A24	1

**Group C**

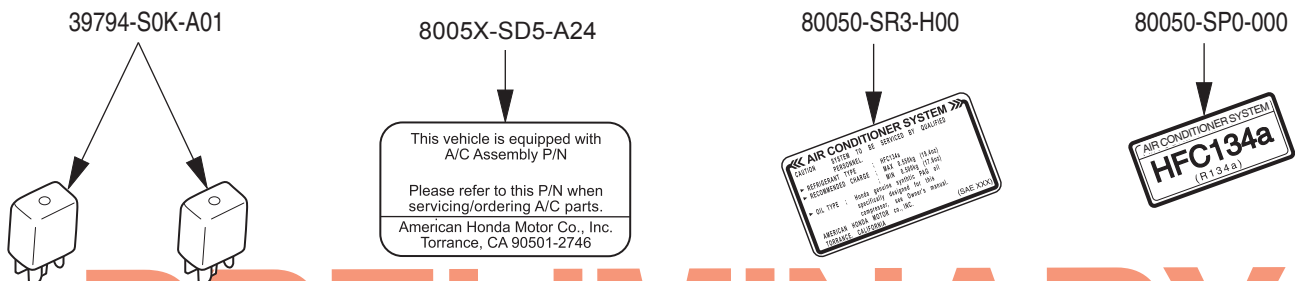

**PRELIMINARY**

**Group B**

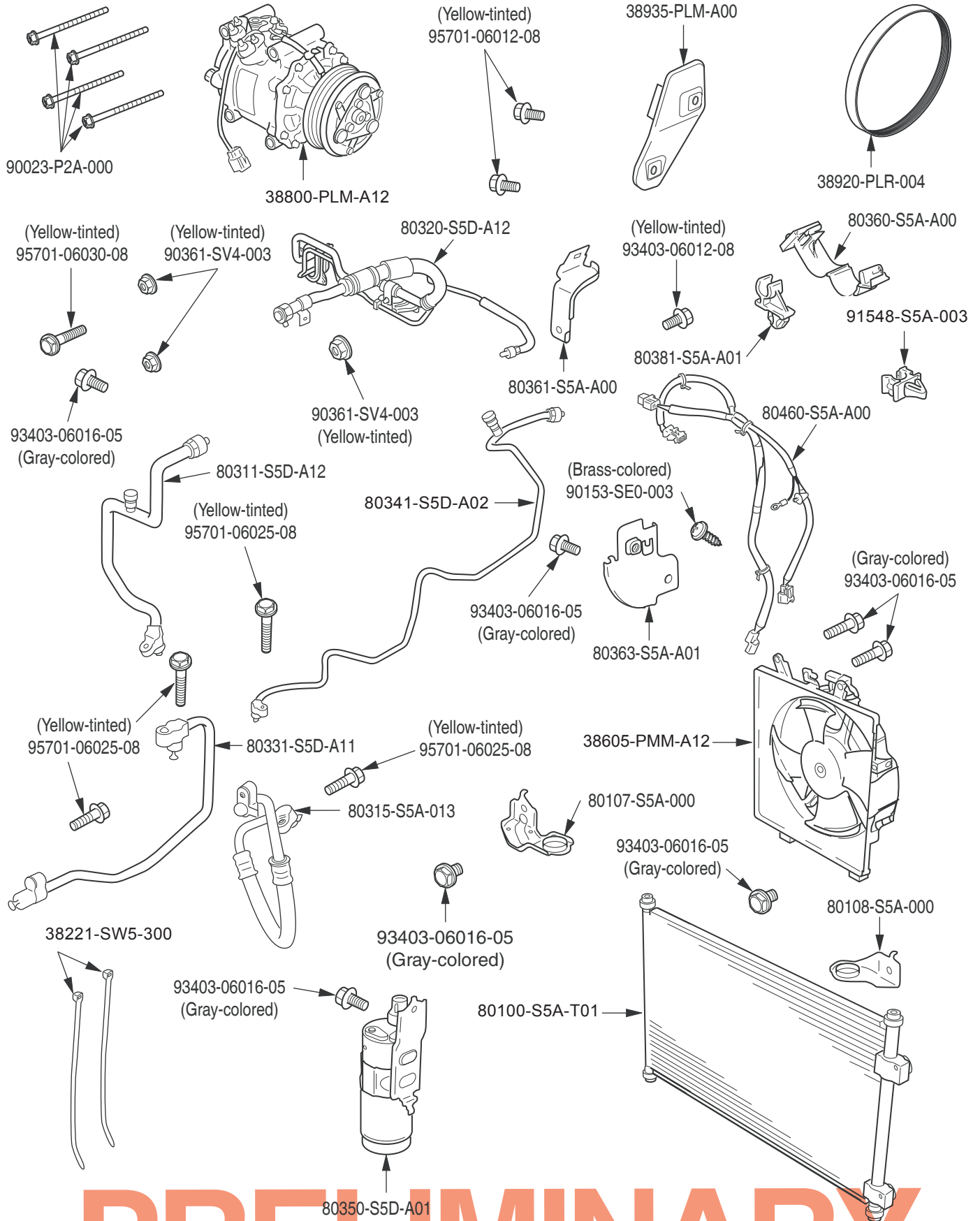

**PRELIMINARY**

- Remove the steel glove box lower frame (two washer-bolts).

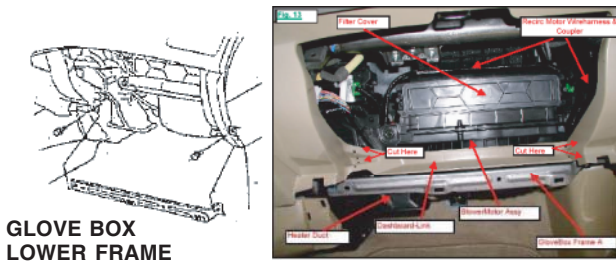

**GLOVE BOX LOWER FRAME**

- Using diagonal cutters (and/or a utility knife), cut out the dashboard-link at the glove box area.

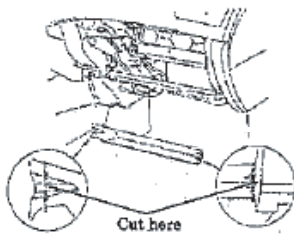

- Remove the passenger's heater duct (one hex screw and two self-tapping screws), and remove the harness connector clip.

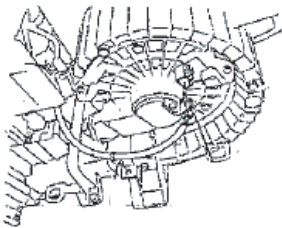
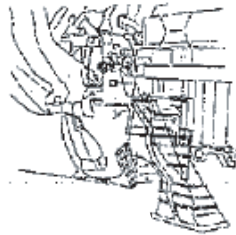

- Remove the blower motor assembly:

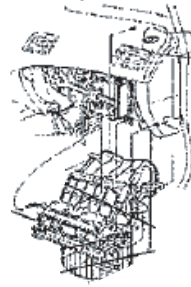

- Remove the three nuts, one flange bolt, and the three washer-screws (black).
- Disconnect the white 14-pin connector at the top of the blower motor, the white 2-pin connector at the bottom, and the green 4-pin recirc motor connector on the right side of the motor.
- Pull the blower motor out past the three studs, and tilt the assembly down. Rotate the assembly toward the center of the vehicle and down to remove it.

- Remove the evaporator housing cover (nine screws), and disconnect the 4-pin power transistor connector. To reach the forward middle screw, you will need a long Phillips #2 screwdriver (150 mm/6" shaft).

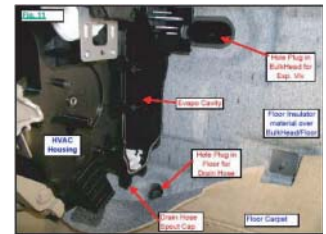
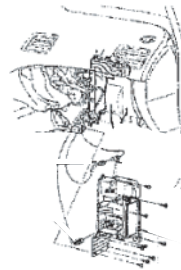

10. Remove and discard the evapo-dummy.
11. Next to the evaporator housing against the front bulkhead, locate and remove the floor insulator plug, which reveals a rubber plug in the front bulkhead. Remove the rubber plug by pushing on the plug. Discard the floor insulator plug and the rubber plug.
12. Below the evaporator housing, under the carpet, locate and remove the floor insulator plug for the drain hose. Discard the insulator plug. Remove and discard the rubber plug in the floor.
13. Get the drain hose and the drain hose clip from the kit. Attach the drain hose clip to the drain hose with the tab ends at the white line on the hose.
14. On the bottom of the evaporator housing, remove and discard the drain-spout plug. Install the drain hose with the clamp to the drain-spout, and route the opposite side out through the hole in the floor. Seat the grommet from the drain hose into the hole in the floor. Check that the hose is not kinked.
15. Get the evaporator and the lower evaporator cover from the kit. Assemble the evaporator and the lower evaporator cover, and ensure that the temp sensor clip(s) are secure in the fins. Insert the evaporator & cover assembly into the evaporator housing until it bottoms out. Assure that the expansion valve (still with cover) is aligned in the center of the hole in the bulkhead.

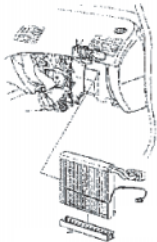

16. Route the temperature sensor wire from the evaporator rearward, and reinstall the evaporator cover with the temperature sensor wire routed through the notch in the cover. Reattach the 4-pin power transistor connector to the evaporator housing cover.
17. Locate the connector for the evaporator temperature sensor, blue-taped to the vehicle harness. Remove the blue tape to free the connector. Connect the temperature sensor, and clip the connector to the hole in the evaporator cover.
18. Get the pollen filter and cover from the kit. Remove and discard the cover from the blower motor (two clips). Install the pollen filter and cover into the blower motor. Observe the arrows on the filter and cover to install properly.

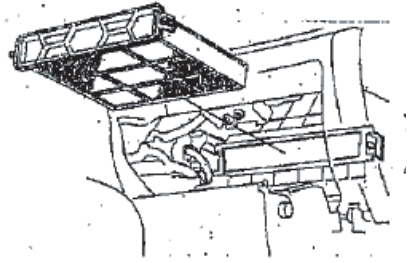

19. Reinstall the blower motor, and reattach the 14-pin wire harness blower motor harnesses and clip to the blower motor.
20. Reinstall the passenger heater duct, and install the wire harness clip.
21. Reinstall passenger dashboard under cover.
22. Reinstall the glove box lower frame A and the glove box.

23. Get the MAX A/C button and the A/C button from the kit. Below the radio, remove and discard the dummy buttons from the heater control panel.

NOTE: To prevent damage to the heater control panel bezel, insert a 0.5 mm flat feeler gauge under the dummy button and leverage the small flat screwdriver to remove the dummies on the surface of the gauge and not on the surface of the bezel. Snap the MAX A/C button and the A/C button into the heater control panel.

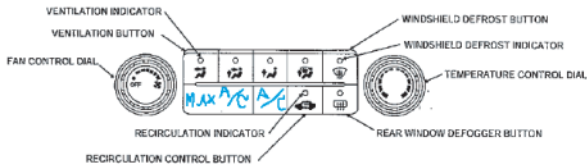

### Installing the Engine Compartment Parts (Compressor and Belt, Condenser, Hoses and Pipes)

24. Remove the right and left cowl cover end pieces by removing the weather strip from each end piece, and pulling up on each cover to release the 5 tabs.
25. Under the hood, remove the cowl cover (three clips, and disconnect the windshield washer hose).
26. Remove the cowl cover place (9 bolts).

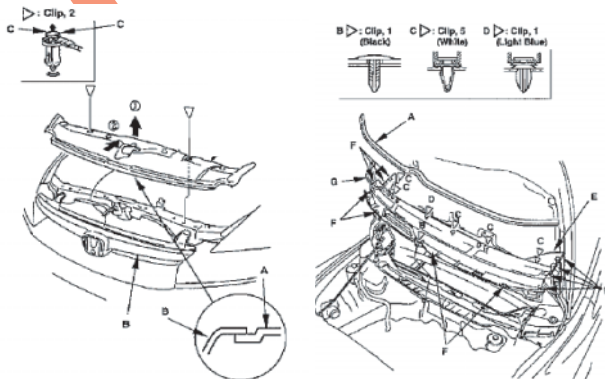

27. Remove the front bumper, two screws and twelve clips.

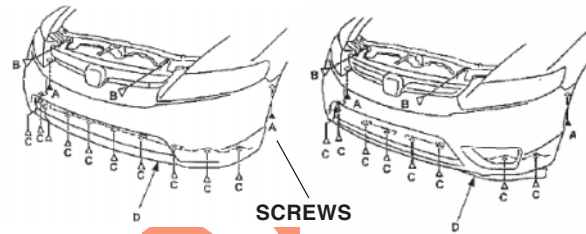

- Remove the radiator cover (four clips).
  - On each side, remove the screw "A" from the fender well area.
  - Remove the clips along the bottom of the front bumper
  - Remove the 2 bumper (grille) clips from the front bulkhead.
  - With the help of an assistant, pull out on each side to remove the retaining tabs. Remove the front bumper and set it aside on a blanket.
28. Remove the power wires from the alternator. Disconnect the connector from the alternator.
29. Using the belt tension tool (special tool #YA9317), release the belt tension and remove the belt from the alternator.
30. Remove the alternator (two 8 mm bolts). Be careful not to loosen the recessed nut.
31. Remove and discard the power steering/alternator belt.



32. Remove the two brackets that secure the front of the radiator, and remove the two bolts from the radiator filler neck. Carefully pull up and out on the right side of the radiator, away from the radiator bulkhead, to lower the compressor in place and to ease the installation of the hoses.



33. Remove the dummy washer-bolts from the compressor bracket. Get the compressor, the two M8 x 65 mm bolts, and the two M8 x 80 mm bolts from the kit.
34. Place the compressor into position on the compressor bracket by engaging the pins on the compressor to the cutouts in the bracket. Install the two upper M8 x 80 mm bolts and the two lower M8 x 65 mm bolts, and securely tighten the bolts.

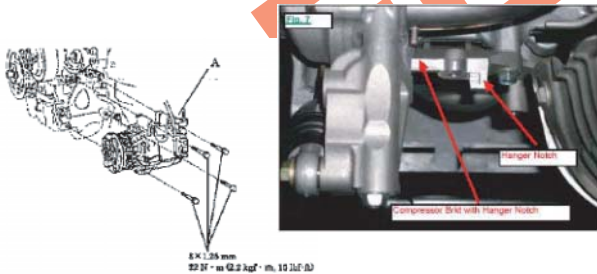

35. Get the discharge hose from the kit. At the front right side of the vehicle, route the hose end of the discharge hose on the right side of the radiator and to the compressor. Remove the 6 mm nut and the discharge port cover from the compressor. Discard the port cover, but save the 6 mm nut. Remove the pipe cover from the end of the discharge hose, and attach the discharge hose to the compressor, reusing the M6 nut.

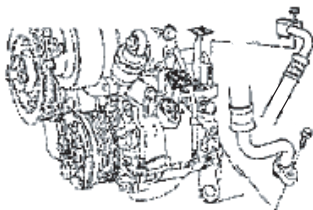

36. Get the suction hose from the kit. Remove and discard the pipe cover and the M6 bolt from the compressor. Remove and discard the suction hose cover. Attach the suction hose to the compressor using the M6 x 25 mm flange bolt from the kit.
37. Reinstall the alternator and wiring. Remove the blind plug from the connector on the bracket, and insert the coupler from the compressor wire harness.
38. Get the belt from the kit. Route the belt around all the pulleys, saving the alternator pulley for last. Using the belt tension release tool, rotate the tool counterclockwise, and install the belt over the alternator pulley. Check to make sure that the belt is properly aligned on each pulley.

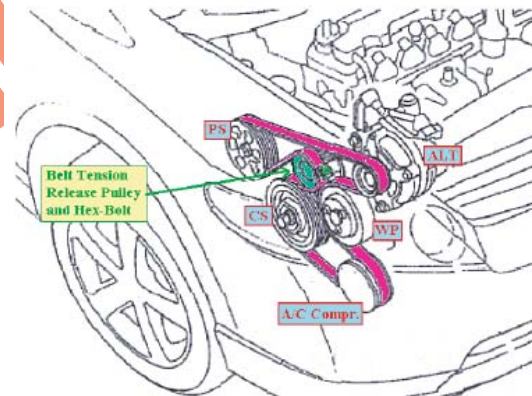

39. Remove the temp sensor coupler with cover, clipped to the left frame, and install the receiver pipe clip from the kit in the square hole in the frame.

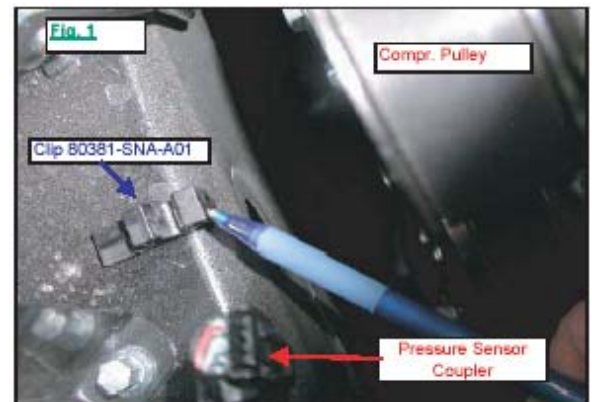

40. Install the other receiver pipe clip from the kit into the hole in the ABS bracket.

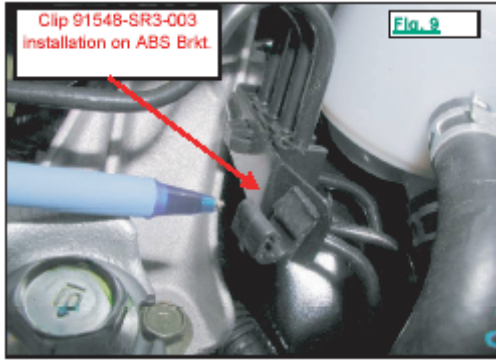

41. Get the receiver pipe from the kit. From inside the engine compartment, route the receiver pipe on the right side of the radiator, and fit the receiver pipe into the clip in the frame rail to hold the pipe.
42. Reinstall the radiator and the filler neck.
43. Get the condenser, the condenser brackets, the two 6 mm x 30 washer-bolts and the two 6 mm x 12 bolts (black) from the kit. Move the discharge hose and the receiver pipe out of the way, and insert the condenser from the bottom up between the bumper and the radiator. Seat the rubber grommets from the condenser into the holes in the lower frame.

NOTE: To prevent damage to radiator fins while installing the condenser, place the rectangular piece of cardboard from the kit against the radiator.

44. Install the right and left condenser brackets with the 6 mm x 30 mm washer-bolts to front bulkhead and to the condenser with the 6 mm x 12 mm bolts then torque to 7.2 lb·ft. Remove the cardboard between the radiator and the condenser.

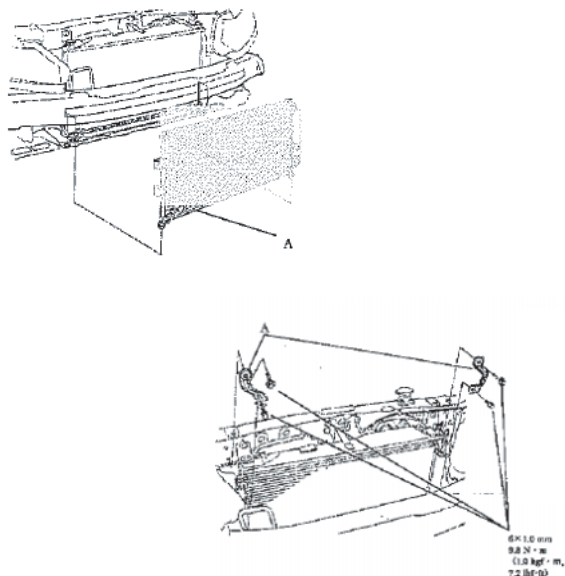

45. At the condenser, remove the caps from the discharge hose and receiver pipe, and remove the caps from the condenser. Lightly oil the O-rings with PAG oil, insert the discharge hose into the condenser, and secure with the 6 mm x 25 mm bolt. Attach the bracket from the discharge hose to the mount on the condenser using a 6 mm x 16 mm washer bolt and torque to 7.2 lb·ft. Insert the receiver pipe into the condenser and secure with the 6 mm x 25 mm bolt and torque to 7.2 lb·ft.

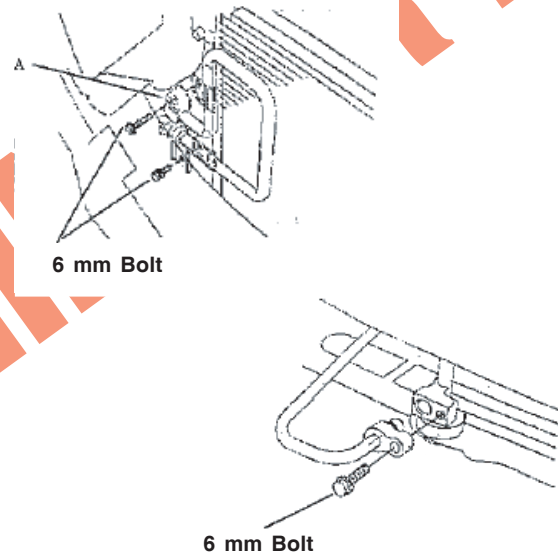

46. On the left side of the engine compartment below the right headlight, locate the pressure sensor connector blue taped to the vehicle harness. Remove the blue tape to free the connector. Plug the connector onto the pressure sensor mounted on the receiver pipe.

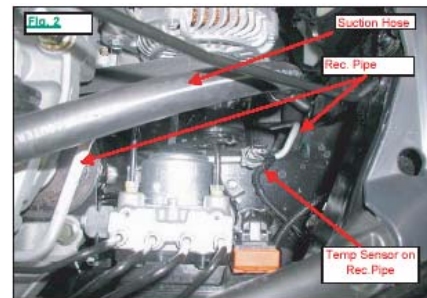

47. Remove the cap from the expansion valve. Get the stud bolt from the kit, and secure its short M6 side to the expansion valve.

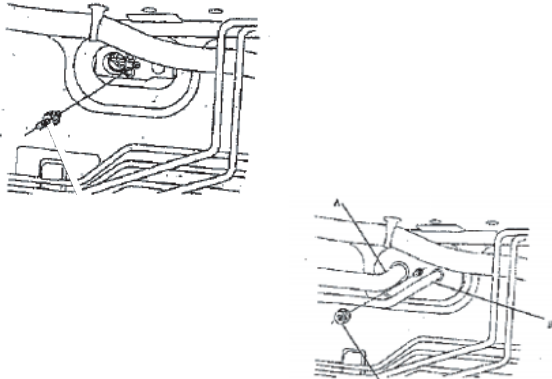

48. Get pipe stay A and B from the kit. Secure pipe stay A to the rear of the engine mount vibration bracket with one 6 mm x 16 mm washer-bolt and torque to 7.2 lb-ft. Secure stay B to the front of the engine mount vibration bracket with one 6 mm x 16 mm washer-bolt and torque to 7.2 lb-ft. Attach the plastic clip to stay B.

49. Get the aircon pipe from the kit. Remove the cap from the flange end of the aircon pipe and lightly oil the O-rings with PAG oil. Guide the flange end of the aircon pipe over the stud bolt of the expansion valve and push the O-ring fittings into the expansion valve. Secure the flange with the M6 nut from the kit.

50. Remove the caps from the suction hose and receiver pipe coupling and lightly oil the O-rings with PAG oil. Remove the caps from the mating coupling of the aircon pipe, and connect the couplings hand tight. Secure the couplings, for the receiver pipe with a 17 mm & 19 mm combination wrench and for the suction coupling with a 24 mm and 27 mm combination wrench. Do not over tighten.

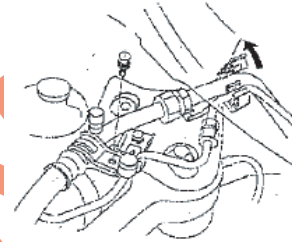

51. Get pipe stay A and B and the clip from the kit. Secure pipe stay A to the rear of the engine mount vibration bracket with one 6 mm x 16 mm washer bolt. Attach the clip to stay B and secure stay B to the front of the engine mount vibration bracket with one 6 mm x 16 mm washer bolt and torque to 7.2 lb-ft. Attach the plastic clip on the aircon pipe to stay A through the rectangular hole.
52. Get the clamp from the kit, attach it to the suction hose and then to pipe, stay B with one 6 mm x 16 mm washer bolt and torque to 7.2 lb-ft. Attach the receiver pipe to the clip on stay B.

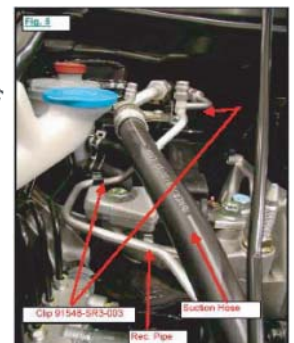
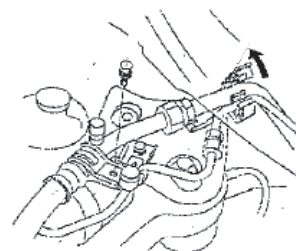

53. Get the AC clutch relay from the kit. Insert the relay in its slot in the fuse box.

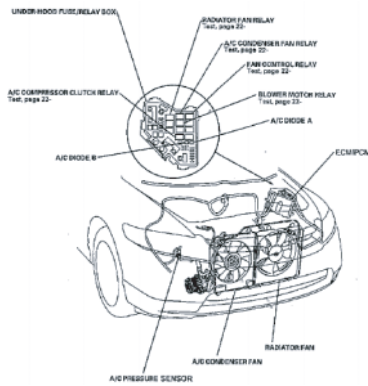

54. Reinstall all removed parts (radiator cover, bumper, cowl plate, cowl cover and windshield washer hose, battery cable). Observe illustration below for proper orientation of radiator cover.

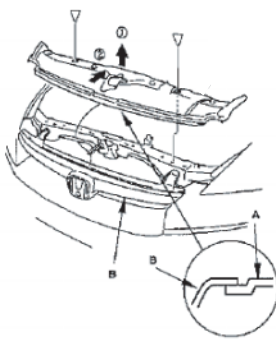

55. Hook up the system to an aircon charging station.

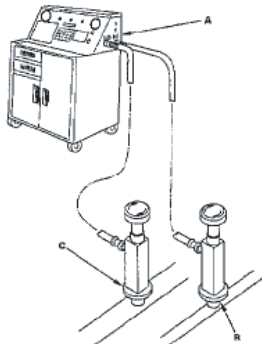

56. Evacuate the system for at least 15 minutes.

57. Reset radio station presets.

58. Install the labels under the hood at a cleaned location near the emission label.

- For USA Registered Vehicles: Aircon INFO-Label and either of the A/C Kit I.D.-Labels
- For USA Registered Vehicles: USA A/C Kit Identification Label
  - For 4-Door Label displaying 80000-SNA-Y00
  - For 2-Door Label displaying 80000-SVA-Y00
- For Canada Registered Vehicles: Aircon R134a-Label

NOTE: If after 15 minutes the pressure has not reached down to 93.3kPa (700 mmHg, 27.6InHg), there is probably a leak in the system. Using a leak detector (Honda Tool & Equipment YGK-H-10PM) find and repair the leak.

59. Charge the system and check system performance. Be sure to add the same amount of NEW refrigerant oil to the system as that was removed during the evacuation procedure(s).

60. Refrigerant leak test.

61. System performance test. With the charge station hoses connected, run the A/C system performance Test per the 2006 Civic Service Manual.