



INSTALLATION INSTRUCTIONS

Accessory

CARGO NET
P/N 08L96-SCV-100

Application

2006 ELEMENT

Publications No.

All 31038

Issue Date

OCT 2005

Put this instruction in the glove box with the vehicle owner's manual.

PARTS LIST

Cargo net

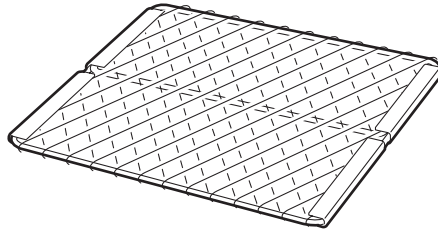

4 Hooks



INSTALLATION

NOTE

- Do not allow the weight of cargo to exceed 22 lb (10 kg).
- Do not store large or fragile objects in the net.
- Do not store objects with sharp edges or corners, as they may damage the cargo net or the vehicle. Wrap such objects in paper or a blanket so they will not contact the net directly.
- The cargo net can be installed in the vertical or the horizontal position.

Vertical Position

1. Fold the cargo net, and install the four hooks in the areas shown.

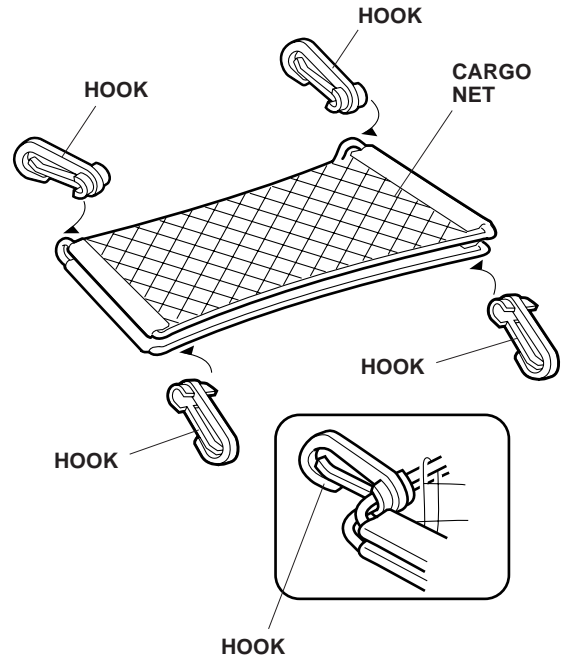

2. Attach the upper straps of the cargo net to the upper cargo area hooks as shown. Attach the cargo net hooks to the lower anchors in the cargo area as shown.

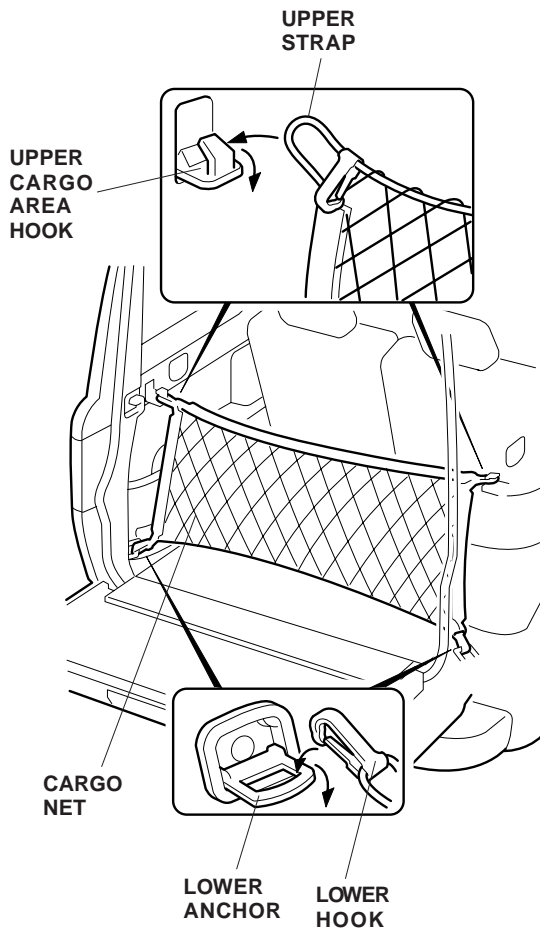

Horizontal Position

3. Attach the four hooks onto the cargo net as shown.

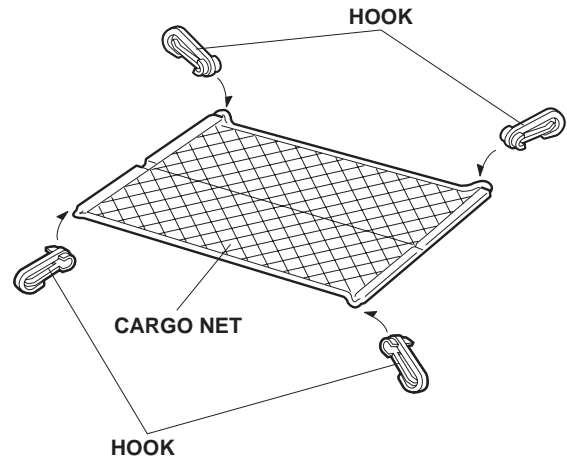

4. Raise the rear seats.
5. Attach the cargo net hooks to the anchors in the cargo area.

