



# INSTALLATION INSTRUCTIONS

Accessory

FLOOR MATS

Application

2008 CIVIC  
4-DOOR

Publications No.

All 37729

Issue Date

AUG 2007

Put this information in the glove box with the vehicle owner's manual.

## PARTS LIST

Floor mat  
(driver's side)

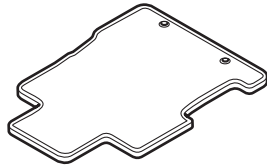

Floor mat  
(passenger's side)

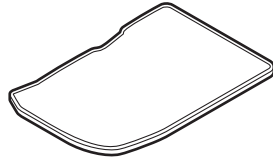

Floor mat  
(rear)

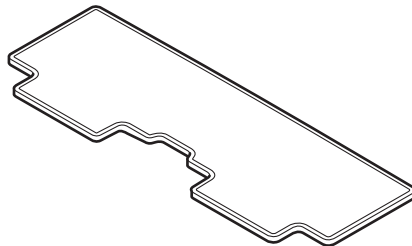

2 Floor mat anchors

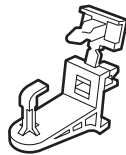

## TOOLS REQUIRED

Utility knife

## INSTALLATION

### NOTE:

- Floor mat anchors are required for the driver's side of the vehicle; these anchors prevent the front floor mat from sliding forward and possibly interfering with the pedals.
- If you remove the front floor mat, make sure you reanchor it when you put it back in your vehicle.
- If you replace the floor mat, use factory floor mats designed to be used with the floor mat anchors.
- If you use a non-factory floor mat in the driver's footwell, make sure it fits properly and that it can be used with the floor mat anchors.
- Do not put additional mats on top of the anchored mat. Additional mats may slide forward and possibly interfere with the pedals.
- Identify each floor mat by the marks on the back of each mat: the floor mats marked "R" or "Passenger's side" go on the right side of the vehicle; the floor mats marked "L" or "Driver's side" go on the left side.

## Installing the Anchors

1. Slide the driver's seat all the way back.
2. Under the front of the driver's seat cushion, extend the slits in the floor carpet with a utility knife (two places).

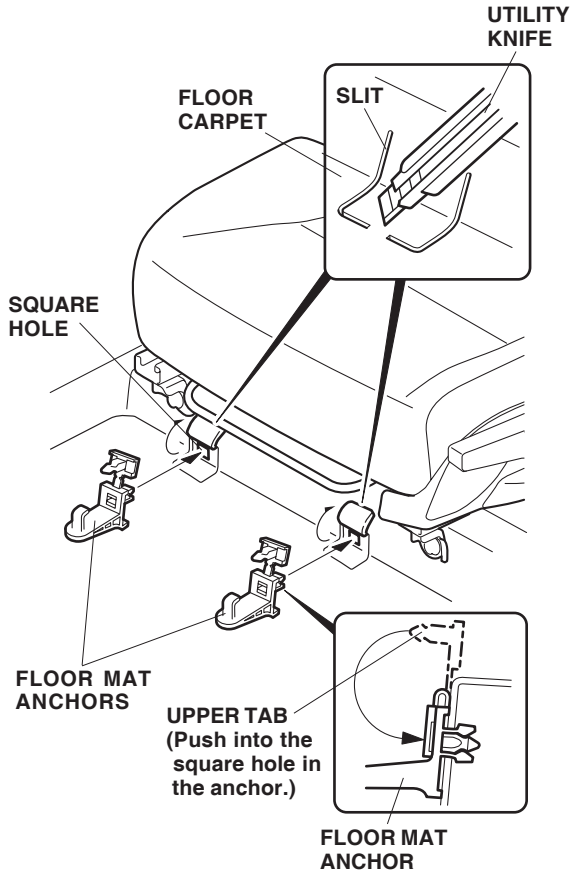

3. Push the lower tab of the anchor into the square hole concealed under the floor carpet. Pull the upper tab down, and push it into the square hole in the anchor as shown. Repeat on the remaining anchor.

## Installing the Floor Mats

4. Install the driver's side floor mat by placing the rings in the floor mat over the anchor pins.

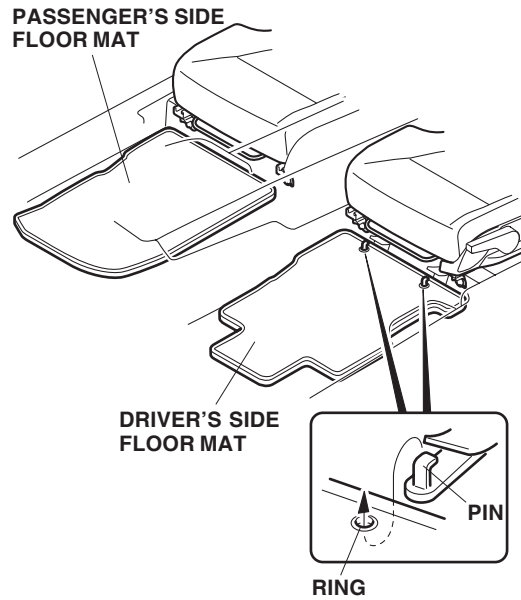

5. Install the passenger's side floor mat.
6. Install the rear floor mat.

