



INSTALLATION INSTRUCTIONS

Accessory

ALL-SEASON MATS
P/N 08P13-TM8-110

Application

2014 INSIGHT

Publications No.

All 50643

Issue Date

OCT 2013

PARTS LIST

Driver's side all-season mat

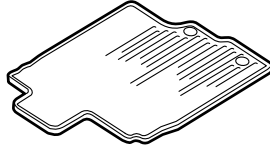

Passenger's side all-season mat

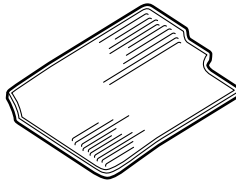

Rear all-season mats

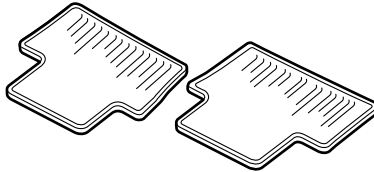

2 Anchors

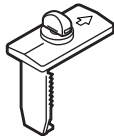

TOOL AND SUPPLIES REQUIRED

Flat-tip screwdriver

Utility Knife

Tape measure

Illustration of the All-Season Mats installed in the Vehicle

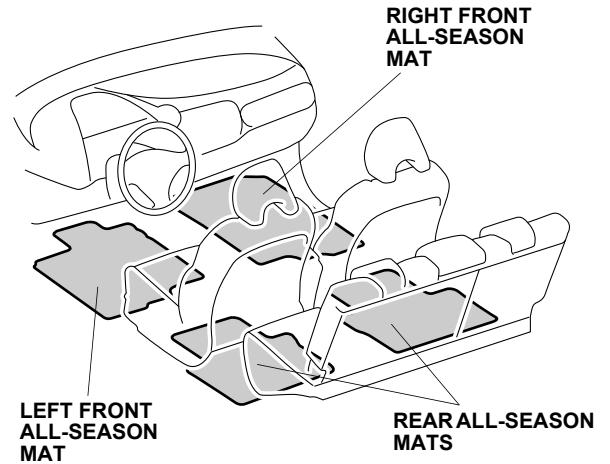

INSTALLATION

Customer Information: The information in this installation instruction is intended for use only by skilled technicians who have the proper tools, equipment, and training to correctly and safely add equipment to your vehicle. These procedures should not be attempted by "do-it-yourselfers."

NOTE:

- Before installing the all-season mats, identify their installation positions.
- Anchors are required for the driver's side of the vehicle; they prevent the all-season mat from sliding forward and interfering with the pedals.
- If you remove the driver's side all-season mat, make sure you reanchor it when you put it back in the vehicle.
- If you replace the all-season mats, use factory mats designed to be used with the anchors.
- Do not put any mats on top of the anchored mat. The additional mat may slide forward and interfere with the pedals.

1. Install the driver's side all-season mat over the anchors as shown.

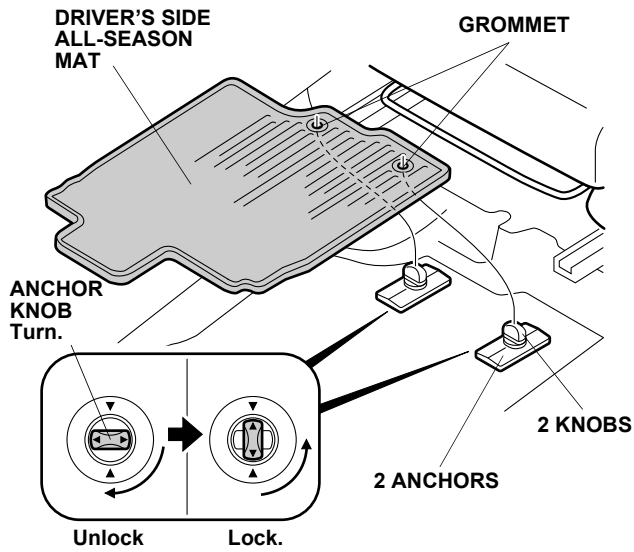

2. Turn the knob on each anchor to secure the driver's side all season mat.
3. Install the passenger's side all-season mat.

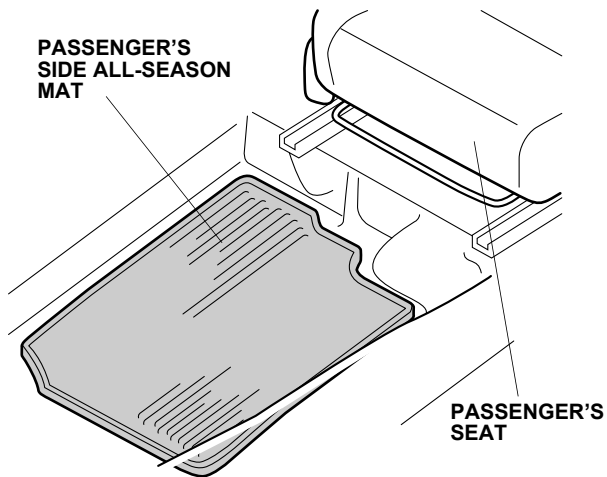

4. Install the right and left rear all-season mats.

